

DAMPA®
Marine Ceiling Systems



Technical Information
DAMPA TILES
Decorative Marine Ceiling System

DAMPA Tiles Marine Ceiling System

Consists of various types of tiles in many configurations with different function and architectural expressions, both in aluminium and steel. All tiles are clip-in tiles to be installed into a concealed suspension system.

Carrier No. 4 and Carrier No. 10 accommodate both Tiles with Bevelled Edge and with Square Edge, although the two types of tiles are not to be mixed within the same gridwork.

DAMPA Tiles with Bevelled Edge

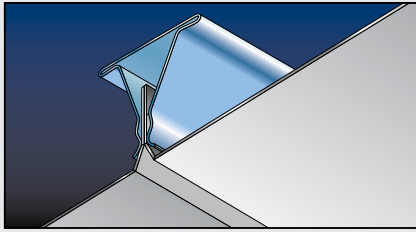

Bevelled on all edges emphasising the rectangular feature.

Available in aluminium and steel and in many sizes both as unperforated, perforated and recessed.

Type AL-15/ST-15 tiles are perforated with 1.8 mm holes at 3.5 mm centres, open area 20.5% and, depending on modular size, with 5-10 mm unperforated border on all four sides. Perforated tiles are as standard provided with black acoustic felt bonded to the reverse side. As optional extras module 600 x 600 mm tiles are available both in alternative perforation patterns and colours of the acoustic felt.

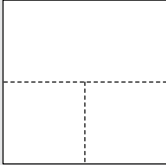

Aluminium

Type AL-15 (Perforated)
Type AL-0 (Unperforated)
Module 300 x 300 x 0.5 mm
(2.4 kg/sq.m)
Module 300 x 600 x 0.7 mm
(2.3 kg/sq.m)
Module 600 x 600 x 0.7 mm
(2.2 kg/sq.m)
Module 625 x 625 x 0.7 mm
(2.2 kg/sq.m)

Steel

Type ST-15 (Perforated)
Type ST-0 (Unperforated)
Module 300 x 600 x 0.5 mm
(4.7 kg/sq.m)
Module 312.5 x 625 x 0.5 mm
(4.6 kg/sq.m)
Module 600 x 600 x 0.5 mm
(4.5 kg/sq.m)
Module 625 x 625 x 0.5 mm
(4.4 kg/sq.m)

DAMPA Tiles with Square Edge

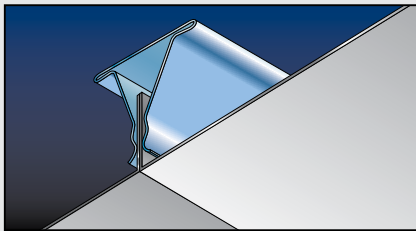

Distinctly flat to form one large neutral ceiling area.

Available in aluminium and steel in many sizes both as unperforated and perforated. Not to be installed in combination with the other types of tiles.

Type AL-15/ST-15 tiles are perforated with 1.8 mm holes at 3.5 mm centres, open area 20.5% and, depending on modular size, with 5-10 mm unperforated border on all four sides. Perforated tiles are as standard provided with black acoustic felt bonded to the reverse side.

Against a surcharge modular tiles 600 x 600 mm are also available in AL-35 perforation with 1.1 mm holes at 2.5 mm centres, open area 17.6% and perforated over the square edge. As optional extras module 600 x 600 mm tiles are available both in alternative perforation pattern and colours of the acoustic felt.

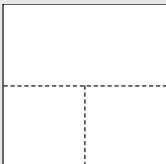

Aluminium

Type AL-15 (Perforated)
Type AL-0 (Unperforated)
Module 300 x 300 x 0.5 mm
(2.4 kg/sq.m)
Module 300 x 600 x 0.7 mm
(2.3 kg/sq.m)
Module 600 x 600 x 0.7 mm
(2.2 kg/sq.m)

Steel

Type ST-15 (Perforated)
Type ST-0 (Unperforated)
Module 300 x 300 x 0.5 mm
(5.1 kg/sq.m)
Module 300 x 600 x 0.5 mm
(4.7 kg/sq.m)
Module 600 x 600 x 0.5 mm
(4.5 kg/sq.m)

DAMPA "Rainfall Ventilation"

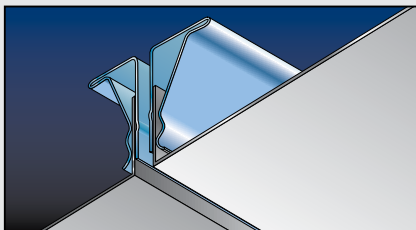

Tiles with Bevelled Edge and with Square Edge can be installed with a gap of variable size crosswise to the carrier for air injection in areas where the ceiling void is used as air supply chamber.

By use of Carrier No. 10 tiles can be installed with an open groove of variable size surrounding each individual tile.

By using DAMPA Spacer Clip No. 1 a groove of 10 mm is achieved. Other on request.

Installation Principles

Unless the carriers can be installed directly to existing gridwork, we recommend a primary grid system to minimise the number of suspension points and provide for greater flexibility during installation.

DAMPA's primary grid system consists of Carrier No. 14 and the well-proven rigid and easily adjustable suspension principle identical to the fire rated DAMPA DCC 300/200 Marine Ceiling System.

Carrier No. 4 is connected to the primary grid by use of Coupling Clip No. 3, whereas Carrier No. 10 is to be secured to the primary grid by use of pop rivets.

Perimeter Details

For ceiling layouts ending with full tiles, use Carrier No. 10 parallel to the other carrier along the perimeter where appropriate.

Where tiles have to be cut, use Edge Trim No. 11 for aluminium and Edge Trim No. 36 for steel tiles.

If so required, Tiles with Bevelled Edge can be installed with an open groove of variable size surrounding each individual tile.

Installation of Tiles

Perimeter tiles are installed first by engaging the cut edge into the edge trim and then securing the profiled edge into the carrier.

Corner tiles must be installed before adjacent perimeter tiles.

Tiles with Bevelled Edge and with Square Edge are secured to Carrier No. 4 (or No. 10) by applying an upward pressure using the palm of the hand at all four corners.

Dismantling

It is possible to remove and reinstate individual tiles anywhere in the ceiling. To remove Tiles with Bevelled Edge and with Square Edge, insert the dismantling tool up into the tile joint close to any of the four corners and pull down gently.

Built-In Heights

The minimum constructional height of a DAMPA Tile Ceiling System installed directly to possible existing gridwork is 38 mm.

The minimum constructional height including DAMPA primary grid/ Carrier No. 14 is 65 mm.

Weight

The weight of the DAMPA Tile Ceiling System largely depends on the chosen size of tiles and the choice of material (steel or aluminium).

Small tile sizes influence the number of Carrier No. 4 or Carrier No. 10 but do not increase the consumption of possible primary gridwork.

The total weight of a 600 x 600 mm DAMPA Tile ceiling is only approx. 2.9 kg per sq.m for aluminium and only approx. 5.2 kg per sq.m for steel.

The additional average weight of possible primary gridwork as illustrated is approx. 1.2 kg per sq.m.

For possible specific project-related weight calculations, please see the weight of each item.

Sound Absorption

To reduce the general sound level and reverberation time within a room, perforated tiles are the most effective solution.

Unperforated tiles offer sound absorption in the low frequency range.

Perforated tiles offer good sound absorbing characteristics within the normal frequency range.

Colours and Surfaces

Ceiling units are stove-enamelled using non-toxic polyester paint providing excellent paint finish and surface protection. DAMPA's standard colour is Pure White matt No. 4747-2. Almost any colour shade is available on request.

For anodised surfaces and other possible finishes, please contact DAMPA.

Classification

Approved as C-class material by leading classification societies and national administrations. This includes both perforated and unperforated executions, with or without bonded acoustic felt and/or inlay of mineral wool, whether sealed in PE-sleeves or not.

Packaging

Tiles and painted perimeter trims are supplied in rigid, non returnable cardboard boxes.

Galvanised suspension components are supplied in standard bundles.

All materials to be stored under cover in a dry, ventilated area.

Identification and Handling on Site

Tile boxes are labelled with contents as well as deck and room number for easy identification and handling on site.

Please contact DAMPA with your specific requirements.

Functionality and Quality

All DAMPA Marine Ceiling Systems are manufactured to high standards within close tolerances to ensure accurate, fast and reliable installation.

The DAMPA Marine Ceiling Systems are produced in accordance with DS/EN ISO 9001:2008

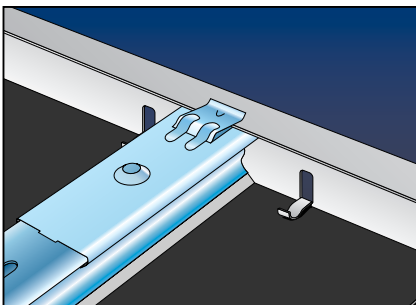

Edge Trim No. 11

Is used to secure cut aluminium perimeter tiles. Carrier Splice No. 4 is secured to the top flange of Carrier No. 4. It also locates on the top flange of the edge trim to maintain the correct tile height.

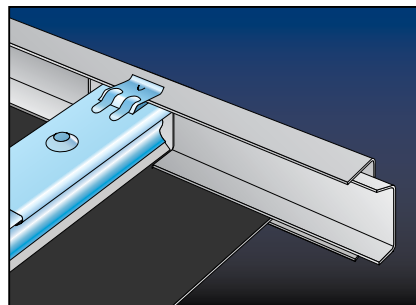

Cut Steel Perimeter Tiles

Are supported using Edge Trim No. 36 and held in position with Wedge No. 4.

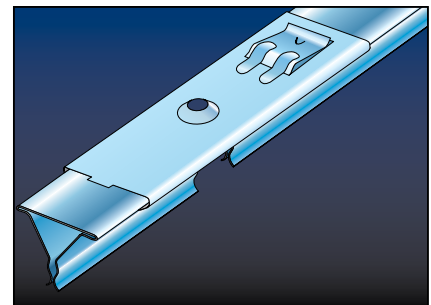

Carrier Splice No. 4

Is centrally positioned over the joints in Carrier No. 4. The distance from the joint to a point of fixation must not exceed 500 mm. A gap of 2-4 mm should be maintained to allow for expansion.

Primary Grid/Carrier and Hanger Distances

All carrier and hanger centres are maximum distances.

- A: Wall to first hanger600 mm
- B: Hanger to hanger1200 mm
- C: Wall first Carrier No. 14600 mm
- D: Carrier No. 14 to next Carrier No. 14 . .1200 mm

Clip-In Carriers

The distance from wall to first Carrier No. 4 or to Carrier No. 10 depends on the ceiling layout, just as the distances between clip-in carriers depend on the modular size of the different tiles available.

If luminaires, air diffusers or integrated fittings are incorporated into the ceiling, it may be necessary to provide additional hangers to accommodate the extra weight.

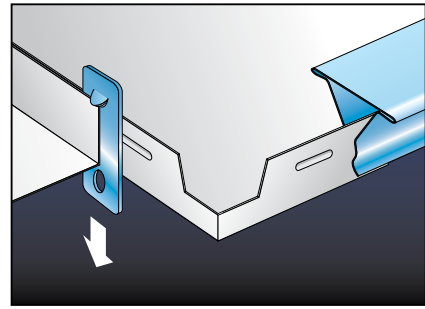

Dismantling Tool

It is possible to remove and reinstate individual tiles anywhere in the ceiling. To remove, insert the dismantling tool up into the tile joint close to the corner and pull down gently.

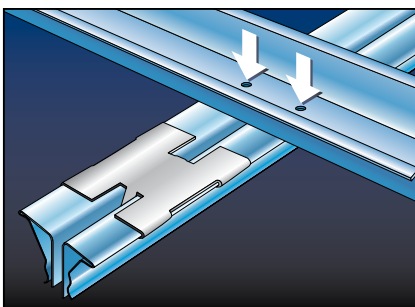
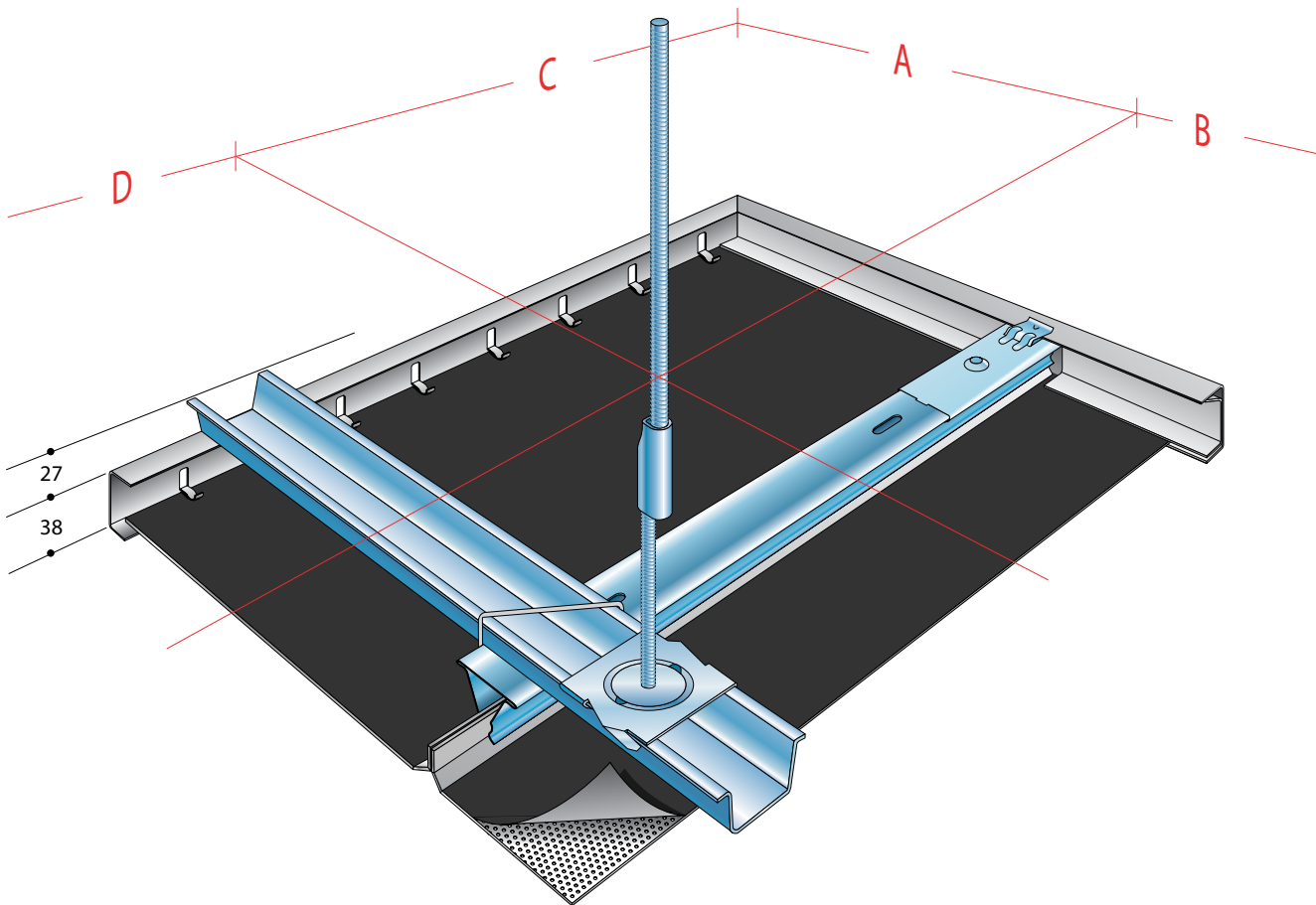

Spacer Clip No. 1

Is used to create a gap of 4 mm between the carries, prior to securing these to the primary grid.

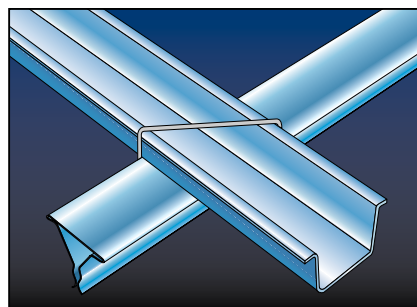

Coupling Clip No. 3

Is used to secure Carrier No. 4 to Carrier No. 14 of the primary grid.

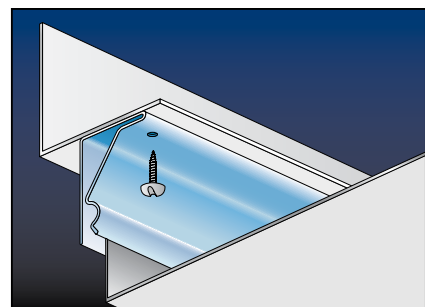

Carrier No. 10

Is used as perimeter detail to support full tiles.



Tiles with Square Edge Tiles with square edge form a distinctly flat and neutral ceiling area. Available in aluminium and steel, in sizes 300 x 300 mm, 300 x 600 mm and 600 x 600 mm, both as perforated and unperforated.



“Rainfall Ventilation” Tiles with Bevelled Edge and with Square Edge can also be installed with an open groove of variable size surrounding each individual tile for ventilation purposes by use of Carirer No. 10.

Carrier No. 14

Height : 27 mm
 Width : 51 mm
 Length : 4000 mm
 Weight : 0.75 kg/lin.m
 Material : 1.0 mm galvanised steel

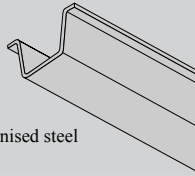
**Carrier No. 4**

Height : 28 mm
 Width : 35 mm
 Length : 4000 mm
 Weight : 0.42 kg/lin.m
 Material : 0.5 mm galvanised steel

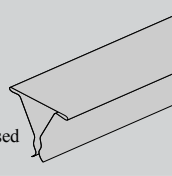
**Edge Trim No. 11**

Height : 38 mm
 Width : 15 mm
 Length : 4000 mm
 Weight : 0.32 kg/lin.m
 Material : 0.6 mm galvanised steel, stove-enamelled

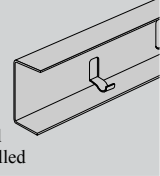
**Runner Splice No. 12**

Height : 20 mm
 Width : 36 mm
 Length : 321 mm
 Weight : 0.15 kg/each
 Material : Galvanised steel

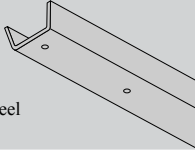
**Carrier Splice No. 4**

Height : 12 mm
 Width : 40 mm
 Length : 110 mm
 Material : Galvanised steel

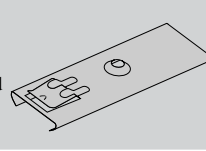
**Edge Trim No. 36**

Height : 38 mm
 Width : 15 mm
 Length : 4000 mm
 Weight : 0.32 kg/lin.m
 Material : 0.6 mm galvanised steel, stove-enamelled

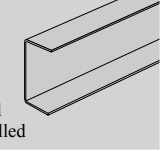
**Suspension No. 1**

Total height : 150 mm
 Weight : 0.05 kg/each
 Material : Galvanised steel

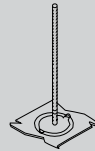
**Suspension No. 3**

(No. 1 but with vibration absorbing rubber bush)

Coupling Clip No. 3

Height : 41 mm
 Width : 64 mm
 Material : Ø 2 mm galvanised spring steel

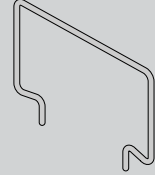
**Wedge No. 4**

Height : 37 mm
 Width : 14 mm
 Length : 274 mm
 Weight : 0.06 kg/each
 Material : 0.5 mm galvanised steel

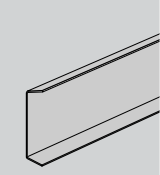
**Rod Clip No. 2**

Total length : 50 mm
 Weight : 0.015 kg/each
 Material : Galvanised steel

**Carrier No. 10**

Height : 33 mm
 Width : 19 mm
 Length : 4000 mm
 Weight : 0.5 kg/lin.m
 Material : 0.6 mm galvanised steel, stove-enamelled

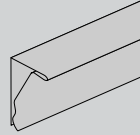
**Pillar Ring**

Height : 16 mm
 Diameter : 200-1000 mm
 Material : 0.7 mm aluminium, chromated and stove-enamelled

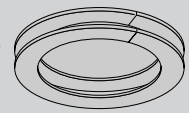
**Threaded Rod M8**

Diameter : 8 mm
 Length : 200, 300, 400, 500, 600 and 2000 mm
 Weight : 0.30 kg/lin.m
 Material : Galvanised steel

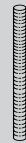
**Spacer Clip No. 1**

Height : 12 mm
 Width : 44 mm
 Length : 60 mm
 Weight : 0.024 kg/each
 Material : 1.0 mm galvanised steel, stove-enamelled

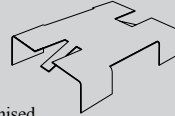
**Access Hatch for Tiles with Bevelled Edge**

Width : 600 mm
 Length : 600 mm
 Material : Galvanised steel or aluminium, stove-enamelled

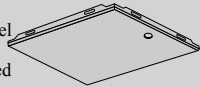
**Suspension No. 4**

(with vibration absorbing rubber bush)
 Total height : 32 mm
 Diameter : 6 mm std. M6 pitch
 Weight : 0.05 kg/each
 Material : Galvanised steel
 (Not to be used in combination with Rod Clip No. 2 and Threaded Rod M8)

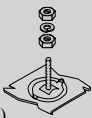
**Dismantling Tool**

Width : 25 mm
 Length : 75 mm
 Material : 0.3 mm spring steel



DAMPA®

Marine Ceiling Systems

DAMPA, DK-5690 Tommerup

Phone: +45 63 76 13 20, fax: +45 63 76 13 99, e-mail: dampa@dampa.dk, www.dampa.dk